

## Installation and Initial Operating Instructions

# Appliances Series 2300 Control Touch (90) / Easy Control (30, 10)



Originalanleitung  
Notice originale  
Original instructions



Anleitung vor  
Gebrauch lesen!  
Lire la notice d'utilisation  
avant l'emploi!  
Read instructions before use!





## MetaTherm Cooking System VacuTherm Cooking System







Datum	01.08.2023
Ersetzt	01.07.2022
Verfasser	VAE
PL	ZUG
Verantwortlich	VAE
Dok-Nr.	X101924E
Revision	3
Seiten	14





# 1 Safety remarks

Setting up, connecting and first operation of appliances may only be carried out by **concessionary specialists** and **personnel authorized by ELRO**. **Assembly and Operating Instructions** must be read beforehand.

Remark	Warning
<p> <b>WARNING</b></p> <p>Front of the appliance is visible when the cover plate is removed</p>	<p> Vor Öffnen des Gerätes spannungsfrei schalten. Disconnect the unit from the power supply before opening it. Déconnecter l'appareil avant de l'ouvrir. Disattivare la corrente prima di aprire l'apparecchio. Antes de abrir el aparato, deben desconectarlo de la red.</p>
<p> <b>WARNING</b></p> <p>Back of the appliance is visible when it is moved away from the wall</p>	<p></p> <p><b>Achtung Hochspannung!</b> Dieses Gerät darf nur durch unseren Kundendienst oder einer von uns autorisierten Fachwerkstätte geöffnet werden. Bei Fremdeingriff erlischt jeglicher Garantieanspruch gegenüber Dritten.</p> <p><b>Attention high-voltage!</b> This appliance may only be opened by our aftersales service or by a specialised workshop authorised by ourselves. In case of external intervention any warranty claim and liability against third parties will be terminated.</p> <p><b>Attention haute tension</b> Seul notre service apres-vente ou un atelier spécialisé designé par nos soins auront le droit d'ouvrir notre appareil. En cas d'intervention extérieure toute revendication d'indemnité et toute responsabilité vis-à-vis de tiers est exclusé.</p>
<p> <b>WARNING</b></p>	<p>Danger of severe injury! The appliance must be disconnected from power and fuse-protected during installation and before maintenance work is performed. Parts under tension must be covered!</p>

Symbol	Remark
 <b>CAUTION</b>	Caution!
 <b>CAUTION</b>	Caution, hot surface
 <b>CAUTION</b>	Caution, hot surface that must be touched
 <b>CAUTION</b>	Caution, escaping steam
 <b>CAUTION</b>	Caution, danger of pinching or crushing

Attention must be paid to the following remarks in all operation modes:

Symbol	Remark
 <b>CAUTION</b>	Inappropriate use (filling food over the filling mark or at 100% output in the continued cooking phase) is dangerous and can cause scalding from hot food that spills over the side of the appliance.
 <b>CAUTION</b>	Use all operational elements such as valves, lid handles and hand wheels with the designated handles.
 <b>CAUTION</b>	If safety elements do not function properly, the appliance may not be put under pressure. Request help from ELRO After Sales Service immediately.
 <b>CAUTION</b>	When working with tilting appliances, open the lid first. The hand wheel brings the pan into the desired position.
 <b>CAUTION</b>	Service and maintenance may only be carried out by ELRO After Sales Service or service companies authorized by ELRO. In other cases, all guarantee and regress claims are invalid, and the appliance may not be cleaned with high pressure (HPC) or a water jet. This also applies to additions or adaptations which were not authorized by ELRO.

## 1.1 Manufacturer

**E L R  O**

Wohlerstrasse 47  
CH-5620 Bremgarten  
[www.elro.ch](http://www.elro.ch)

## 1.2 ELRO After Sales Service



+41 (0)56 648 94 11



[cs@elro.ch](mailto:cs@elro.ch)

# Contents

Page

<b>1</b>	<b>Safety remarks</b> .....	<b>2</b>
1.1	Manufacturer .....	4
1.2	ELRO After Sales Service .....	4
<b>2</b>	<b>ELRO Appliance Series 2300 Touch / Easy</b> .....	<b>6</b>
2.1	Type designation .....	6
2.2	Appliance number / Data plate .....	6
2.3	Declaration of conformity .....	6
<b>3</b>	<b>Appliance overview</b> .....	<b>7</b>
3.1	Technical data .....	7
<b>4</b>	<b>Transport</b> .....	<b>7</b>
<b>5</b>	<b>Positioning appliances</b> .....	<b>8</b>
5.1	Appliance mounted on feet .....	8
5.2	Appliance mounted on plinth .....	8
5.3	Appliance mounted on CNS base .....	8
5.4	Bolting down the appliance .....	8
5.5	Wall mounting / ELRO Installation wall .....	9
5.5.1	Self-securing wall mounting suspension / Horizontal adjuster .....	9
5.5.2	Lifting truck (8).....	10
5.5.3	Hanging the appliance .....	10
5.5.4	Setting the working height .....	10
5.6	Checking suspension .....	10
5.7	Mounting the remote control unit.....	10
5.8	Wall panel.....	11
5.9	Assembly .....	11
5.9.1	Hygienic link .....	12
5.10	Mobile Appliances .....	12
<b>6</b>	<b>Connection</b> .....	<b>13</b>
6.1	Appliance connections .....	13
<b>7</b>	<b>Commissioning</b> .....	<b>13</b>
7.1	Appliance with control Touch (90).....	13
7.2	High-speed .....	14
<b>8</b>	<b>Maintenance</b> .....	<b>14</b>
<b>9</b>	<b>Decommissioning and disposal</b> .....	<b>14</b>

## 2 ELRO Appliance Series 2300 Touch / Easy

Congratulations on your purchase of an ELRO series 2300 appliance. Please read these Assembly Instructions, as well as the Operating Instructions carefully. Pay attention to remarks and recommendations, as well as cleaning and maintenance instructions. These contribute to the proper functioning of appliances.

### 2.1 Type designation

Pressure cookers/cookers DGNx, DGNSx, JGNx, JKx, JRx  
 Pans DBGNx, DBGNix, DBGNSx, DBKGNx, DBKGSx, PGNx, PKGNx  
 Speed Speedx  
 x = size

### 2.2 Appliance number / Data plate

The appliance number (1) is engraved on the casing. The data plate (2) is located on the appliance casing on over the electric box and in the back near the mounting suspension.

Gerät  
Device ELRO Multifunktions-Druckgarbraisière  
Modell 2300, nicht kippbar

Typ  
Type DBGN22-EDS-90

Nr.  
No 704413 Datum  
Date 12.09.2022

400V 3LPE 50/60Hz / 15.10 kW / 21.70 A

IPX6 / IPX9		Kochraum Chambre de cuisson Cooking Chamber		Heizregister Système de chauffage heating system	
		prim.	sec.		
Inhalt Capacité Capacity (l)	90	0	0		
Temp. (°C)	107	0	0		
Druck Pression Pressure (kPa)	34	0	0		
Medium Milieu	H <sub>2</sub> O				



ELRO  
CONNECT



E-331Z-4142-0U7Z

ELRO-Werke AG, CH-5620 Bremgarten

**ELRO**

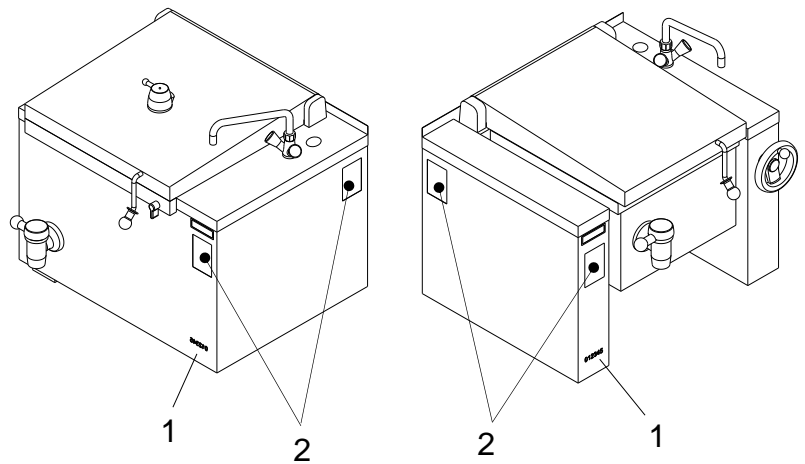

### 2.3 Declaration of conformity

You will find the declaration of conformity as download in the internet.

### 3 Appliance overview

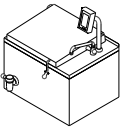
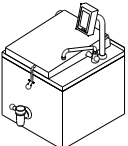
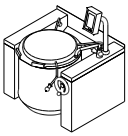
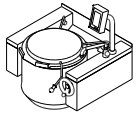
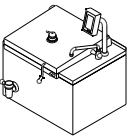
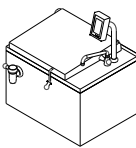
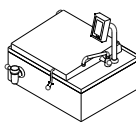
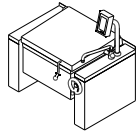
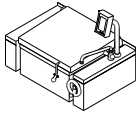
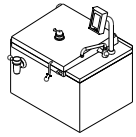
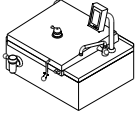
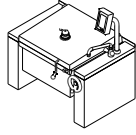
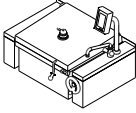
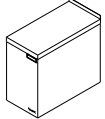
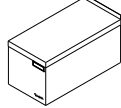
Image	Abbreviation	Description	Abbreviation	Image
	<b>JGN</b>	Kettle GN form Touch Control 90 Easy Control 30 Easy Control 10		
	<b>JR</b>	Kettle, round Touch Control 90 Easy Control 30 Easy Control 10		
	<b>JK</b>	Tilting kettle, round Touch Control 90 Easy Control 30 Easy Control 10	<b>JK-C</b>	
	<b>DGN DGNS</b>	Pressure cooker Pressure cooker with High-speed Touch Control 90		
	<b>PGN</b>	Flexi-pan with (ED/EDS/EDP) Touch Control 90 Easy Control 30	<b>PGN-C</b>	
	<b>PKGN</b>	Tilting Flexi-pan with (ED/EDS/EDP) Touch Control 90 Easy Control 30	<b>PKGN-C</b>	
	<b>DBGN DBGNI DBGNS</b>	Pressure bratt pan (ED/EDS/EDP) Pressure bratt pan with integrated High-speed Pressure bratt pan with High-speed Touch Control 90	<b>DBGN-C</b>	
	<b>DBKGN DBKGNS</b>	Tilting pressure bratt pan (ED/EDS/EDP) Tilting pressure bratt pan with High-speed Touch Control 90	<b>DBKGN-C</b>	
	<b>Speed</b>	High-speed	<b>Speed-C</b>	

#### 3.1 Technical data

Dimensions, weight, capacity, and other technical data for the corresponding appliance can be found in the Dimensional drawings / Installation plan and in the General remarks.

### 4 Transport

The appliance is delivered ex works on pallets.

## 5 Positioning appliances

Appliances are to be positioned on location according to the valid installation plans / dimensional drawings and General Remarks.

All the valid, country-specific and local regulations of the responsible supervisory authorities must be followed. Make sure that:

- **No lines** have been installed in the shaded area on the dimensional drawings.
- The connection cable is not damaged in any way (squashed, cut).
- If a cable is damaged, the appliance may not be put into operation! Cables may only be replaced by ELRO After Sales Service or personnel instructed by ELRO, in order to guarantee high pressure cleaning HPC suitability.
- All the necessary operational equipment according to the installation plans / dimensional drawings and instructions are available on site.

### 5.1 Appliance mounted on feet

With the help of **bolts** (1) adjust the appliance level to working height (usually 900mm). Use a water level! The adjustable foot must be fixed by a locknut.

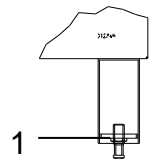

### 5.2 Appliance mounted on plinth

With a lifting truck, raise the appliance with pallet 20mm over the plinth. Position the appliance above the plinth on a board approx. 500 mm from the wall.

Pull all the connection cables through the mains lead cleat in the appliance rear wall to the front. Slide the appliance onto the plinth (working height 900mm as a rule) until the upper upstand meets the wall.



Remove the board and position the appliance so that the lateral recess between the appliance and the plinth is 20mm (tilting appliance 10mm) on the left and right.

Level the unit so that it is horizontal in both dimensions and matches the height of the neighbouring unit to ensure a hygienic connection using ELRO Hygienelink.

### 5.3 Appliance mounted on CNS base

Slide the CNS base in the foreseen position so that the front edge is at 650mm distance from the wall (10 mm base back wall / wall on site).

Make sure the floor construction is appropriate for this type of mounting before drilling the holes for mounting. Level the base so that it is in the horizontal position in both dimensions.

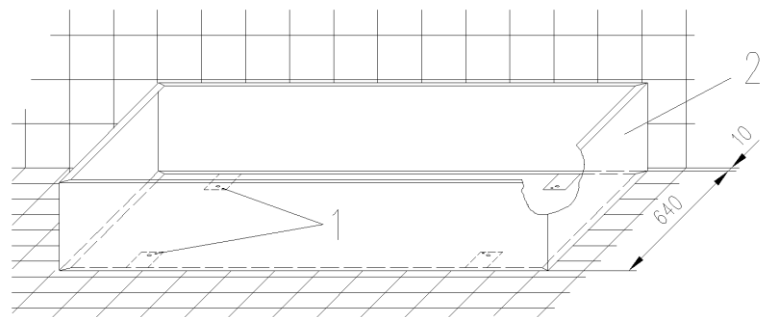

Drill 4 holes in the connection plates (1) ( $\varnothing 8\text{mm}/45\text{mm}$  depth). Insert the plastic plugs M6. Screw the base to the floor with the four hexagon head screws M6x30mm.

Then proceed as described for appliances mounted on a plinth.

### 5.4 Bolting down the appliance

Drill two holes with  $\varnothing 7\text{mm}$  in the upstand at the back (X) and countersink them. Mark the position for the plugs through the two holes. Move the appliance away from the wall and drill the holes and insert the plugs.

Bolt the appliance to the wall with two countersunk head screws 6x40mm.

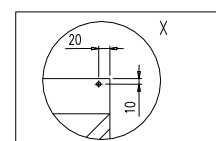



## 5.5 Wall mounting / ELRO Installation wall

Make sure that the mounting wall is suited for use with M10 straddling plugs!

Measure the placement of the appliance on the finished wall (plaster, tiled). Use a marking gauge (1) or draw in the appliance contours (1) and the mounting holes according to the dimensional drawing/installation plan.

Wall mounting	Appliance type
Type 90/2300	JGN1/DGN1
	JGN2/DGN2/PGN2/DBGN2
	JGN3/DGN3/PGN3/DBGN3
	JGN3-H/DGN3-H
	PGN1/DBGN1
Type 91/2300	JK1-75/100
	JK2-140
	JK3-200
	PKG3/DBKGN3
	PKG2/DBKGN2
	PKG1/DBKGN1
Type 92/2300	JR1-60/1-80/1-100
	JR2-140
	Speed15/20/30/43

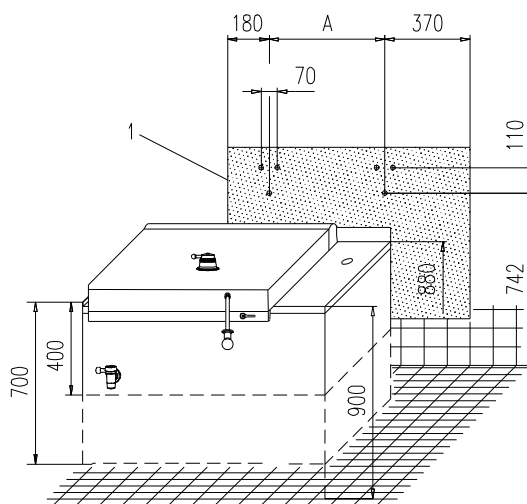

Recheck the dimensions drawn on the wall (A = reference dimension). If dimensions are correct, drill the holes.

If the first or last appliance in a row, or a single appliance is being installed, also drill the holes for the wall panel.

### 5.5.1 Self-securing wall mounting suspension / Horizontal adjuster

Depending on the appliance to be installed, use the self-securing wall mounting suspension (3):

Wall mounting suspension (3)	Appliance	X (3)
Type 90/2300	JGN DGN(S) PGN DBGN(S) JR	
Type 91/2300	DBKGN(S) PKG3 JK	
Type 92/2300	High-speed	
Horizontal adjuster (7)	Alle	

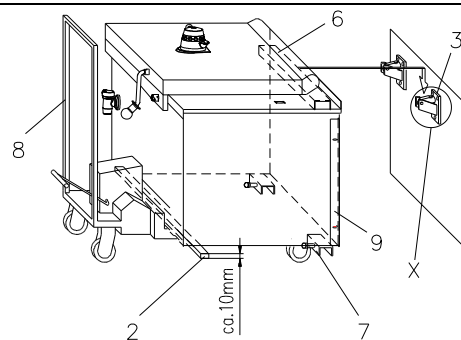

Mount the suspension (3) to the wall with the plugs / screws included. Make sure that the pivoting bolts for the wall suspension (3) are placed as shown in the diagram and that the adjusting screws protrude 10 mm.

The two horizontal adjusters (7) are pre-assembled. Make sure that the screws for the horizontal adjusters (7) are screwed in so that they do not protrude from the back wall.

## 5.5.2 Lifting truck (8)

Mounting appliances with a height of 700 mm requires a lifting truck (8) with at least 100mm stroke and sufficient load capacity. Appliances with a height of 400mm (C) require a lifting truck with at least 500mm stroke.

## 5.5.3 Hanging the appliance

Place the appliance at an angle by underlaying it by approx. 10mm (2). Raise the appliance. The working surface must be at least 970mm over the finished floor. Slide the appliance against the wall. Use the marking gauge (1) or the appliance contours (1). Lower the appliance. The fixing angle (6) must be **behind** the pivoting bolts of the wall suspension (2)

## 5.5.4 Setting the working height

The working height must be set according to the dimensional drawing / installation plan, off the finished floor (as a rule 900mm). Use a water level!

The appliance must be moved away from the wall to correct the height. Correction of height ( $\pm 10$ mm), as well as longitudinal tilt can be carried out by adjusting the wall suspension bolts (3). Correction in the depth tilt can be carried out by adjusting the two horizontal adjusters (7).

## 5.6 Checking suspension

If the appliance has been mounted according to specifications, the appliance should not move, even in the case of strong rocking. If this is not the case, the adjustment and securing procedure must be repeated as described above.

## 5.7 Mounting the remote control unit

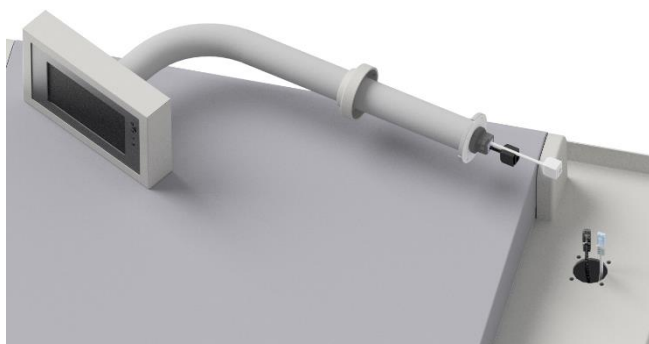

Remove control 90 touch from the carton box



Connect the patch cable - **pay attention to the colour!**



Fasten the control unit to the console with 4 Allen screws / lock washers



Align the control 90 or 30 with the open cover and screw tight

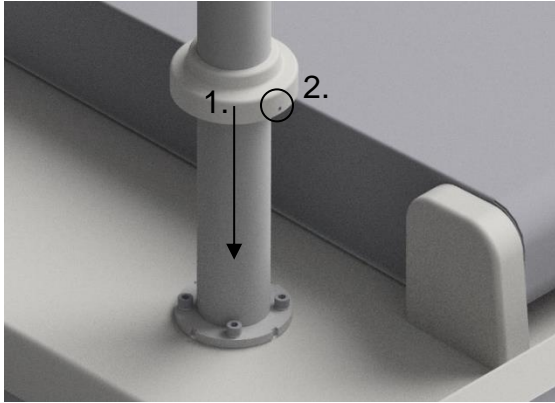

Push down the cover ring (1) and fix it with the grub screw (2).

## 5.8 Wall panel

In order to ensure that the appliance is suited for cleaning (IPx5 (Easy); IPx6 und IPx9 (Touch)), the wall panels for the first and last appliance of a cooking row must be installed with end angles and sealed with silicone.

## 5.9 Assembly

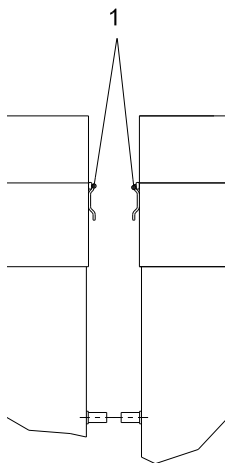

If several appliances are being assembled, these appliances must be equipped with a clip rail (1) at the top right or left, and with one or two bolts in the front right or left.

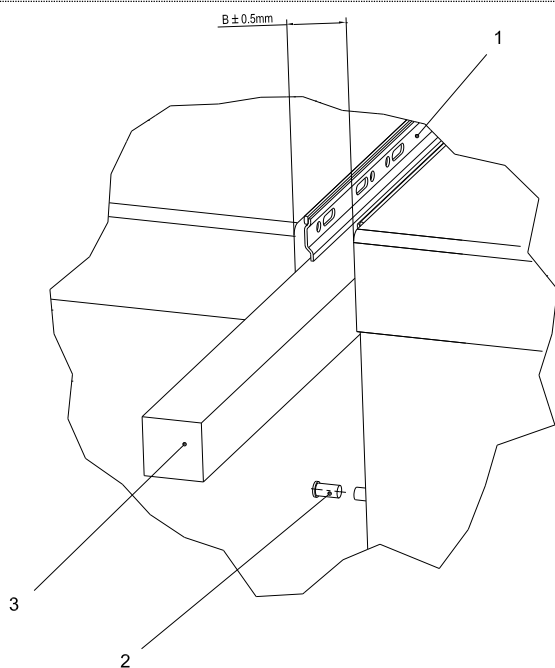

Depending on the distance between the appliances, use the appropriate distance gauge (3). Level the appliances with a water level. The dimension (B) between the appliances may not exceed a tolerance of +/- 0.5mm!

### 5.9.1 Hygienic link

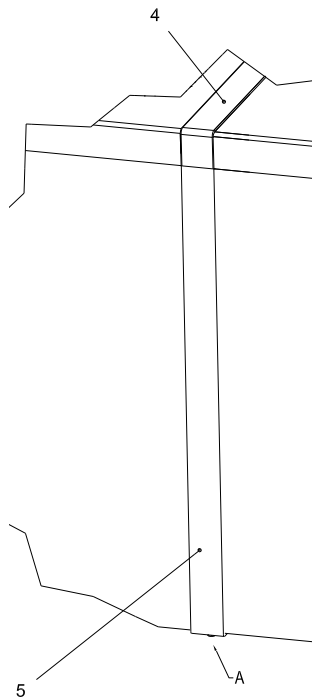

Slide the hygienic link (4) over the assembly rail into the clip rail. Make sure seals have been assembled correctly!

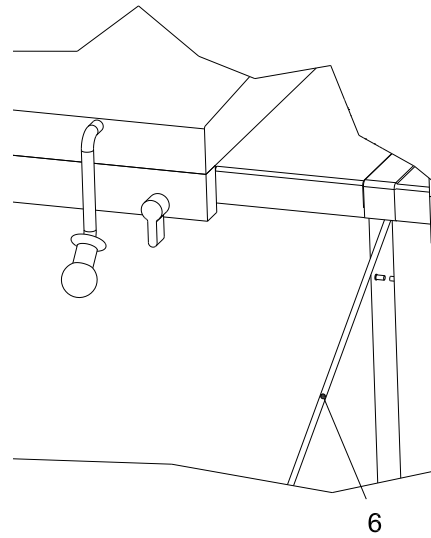

Secure the hygienic link with the help of an extended socket head wrench.

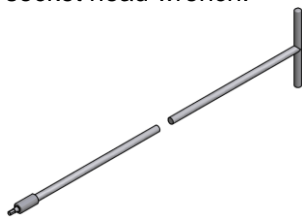

(6) WZ12220

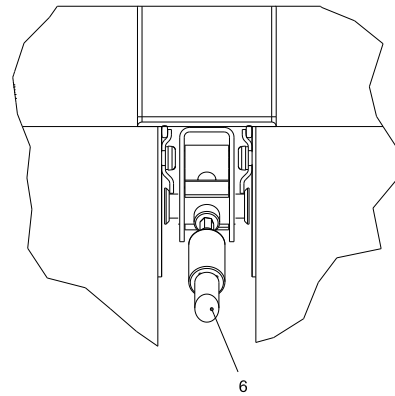

Place the hygienic link front (5) over the bolts (2) and tighten these with the screw (5.1) on the appliance under side.

Ansicht A

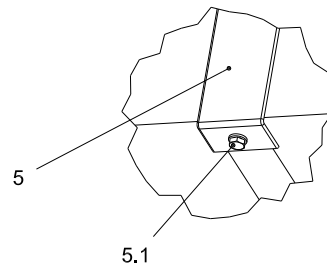

### 5.10 Mobile Appliances

In order to guarantee optimal functioning, appliances must be placed on a floor with absolutely no gradient. Appliances are ready for operation when they leave the factory.

## 6 Connection

The appliances must be connected to the power network and or sanitation system by a concessionary specialist and in accordance with the valid General Remarks / dimensional drawings / installation plans.

The valid, country-specific and local regulations of the responsible supervisory authorities must be followed. The protection measures to prevent accidental contact of parts under charge must be checked and ensured according to EN 60 335-1 after completion of assembly.

The protective tubing for connections lines on site must be dimensioned so that electrical safety is not impaired (i.e. enough creepage and clearance, no squashing of cables).

Always use only the original media connections and the corresponding quick couplings with mobile appliances. Adhere to the specifications in the General Remarks / installation plans.



Only new, detachable hose sets enclosed with the appliance delivery may be used for connection to the water supply system. Old hose sets that have already been used must not be reused.

### 6.1 Appliance connections

For detailed information, please refer to the General remarks and/or the Installation plan.

## 7 Commissioning

All functions which can be changed with the user code for cooking programs / settings and are described in the Operating Instructions. Other settings must be carried out by ELRO After Sales Service or personnel instructed by ELRO.

Commissioning of mobile appliances must take place on a floor with absolutely no gradient and with the wheels locked.

### 7.1 Appliance with control Touch (90)

No.	Image	Activity
1.		Open lid.
2.		Keep display pressed for 2 seconds, the QCS Touch control switches ON, main contactor switches.
3.		Select operation mode Cooking, set temperature to the maximum possible nominal value (upper limit of the adjustment range).
4.		Set cooking time continuous operation (--:--:--).
5.		Start cooking process with .

Check:

After approx. 5 minutes check if the cooking chamber bottom is warm.









If YES, continue with no. 6.

If NO, check electrical connection and repeat the function check no. 1-5.

6.		Switch the appliance off with .
----	--	---------------------------------

Attention: If the cooking chamber is filled with water, empty and wipe dry with a cloth.

## 7.2 High-speed

No.	Image	Activity
1.		Open lid.
2.		Keep display pressed for 2 seconds, the QCS Touch control switches ON, main contactor switches.
3.		Select operation mode Speed.
4.		Set 3 minutes. If two appliances are connected to High-speed, carry out this setting on both appliances.
5.		Start Speed with  . If two appliances are connected to High-speed, start both appliances simultaneously. Make sure that the setting Master/Slave has been carried out correctly and that both appliances have been assigned a unique IP address. The master appliance must first be supplied with steam, after 3 minutes the second appliance (Slave) should be supplied with steam.
6.		Stop Speed with  .
7.		Switch the appliance off with  .

### Attention:

If the cooking chamber is filled with water, empty and wipe dry with a cloth.

## 8 Maintenance

	Check interval		Remark
	Every 4 years	Every 8 years	
Appliance lid	X		checked for proper functioning
Nonreturn valve MB / AMB / WDS	X		checked for proper functioning
easy-tilt - Manual - Electronic	X		checked for proper functioning
Autolift	X		checked for proper functioning
High-speed	X		checked for proper functioning
ELRO safety valve	X		checked for proper functioning
ELRO multifunction valve	X		checked for proper functioning
Float-frying Fritomat		X	Safety components must be replaced every 8 years

## 9 Decommissioning and disposal



For decommissioning and disposal of the appliance, contact ELRO customer service.

Old units contain recyclable materials.

Dispose of old devices in an environmentally friendly manner using a suitable collection system.